

Nominal data

Type	5212 NN	
Nominal voltage	VDC	12
Nominal voltage range	VDC	7 .. 14
Speed	min ⁻¹	3150
Power input	W	6.2
Min. ambient temperature	°C	-20
Max. ambient temperature	°C	70
Air flow	m ³ /h	216
Sound power level	B	5.6
Sound pressure level	dB(A)	46

ml = Max. load · me = Max. efficiency · fa = Running at free air · cs = Customer specs · cu = Customer unit
Subject to alterations

Technical features

General description	Free air power consumption, these values may be considerably higher at the operating point.
Housing material	Fibreglass-reinforced plastic (PBT)
Impeller material	Fibreglass-reinforced plastic (PA)
Mass	0.310 kg
Dimensions	127 x 127 x 38 mm
Direction of air flow	Air exhaust over bars
Direction of rotation	Left, looking at rotor
Bearing	Ball bearings
Lifetime L10 at 40 °C	57500 h
Lifetime L10 at maximum temperature	25000 h
Connection line	Single strands AWG 22, TR 64, bared and tin-plated.
Motor protection	Protected against reverse polarity and locking.
Locked-rotor protection	With electronic blocking and overload protection
Approval	VDE, CSA, UL, CE
Option	Vario-Pro fan

5212 NN

DC axial compact fan

Product drawing

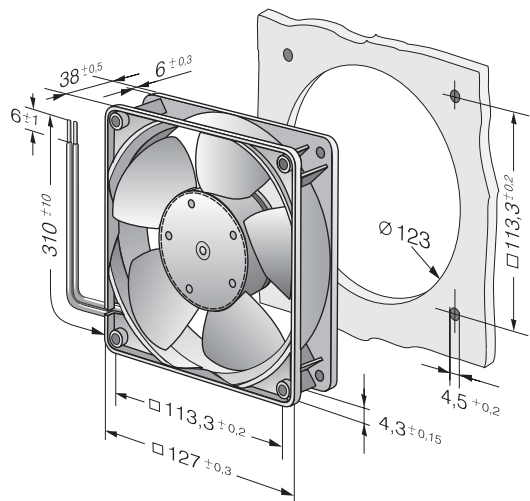

Charts: Air flow

